



Telehandler Attachments					
Operating Weight (less bit).....	374 lbs.	370 lbs.	392 lbs.	386 lbs.	454 lbs.
Digging Depth (without extensions).....	62"	62"	62"	62"	72"
Shaft Diameter - Round.....	2.5"	-	2.5"	-	-
Shaft Diameter - Hex.....	2.0"	2.0"	2.0"	2.0"	2.5"
<b>RPM</b>					
@ 12 gpm (45 L/min.).....	57 rpm	57 rpm	-	-	-
@ 17 gpm (64 L/min.).....	80 rpm	80 rpm	41 rpm	41 rpm	-
@ 18 gpm (68 L/min.).....	-	-	-	-	46 rpm
@ 21 gpm (70 L/min.).....	99 rpm	99 rpm	51 rpm	51 rpm	-
@ 22 gpm (83 L/min.).....	-	-	-	-	56 rpm
@ 23 gpm (87 L/min.).....	109 rpm	109 rpm	56 rpm	56 rpm	-
@ 26 gpm (98 L/min.).....	-	-	-	-	64 rpm
@ 30 gpm (114 L/min.).....	-	-	70 rpm	70 rpm	77 rpm
@ 32 gpm (121 L/min.).....	-	-	-	-	82 rpm
@ 34 gpm (129 L/min.).....	-	-	-	-	87 rpm
@ 36 gpm (136 L/min.).....	-	-	-	-	92 rpm
@ 37 gpm (140 L/min.).....	-	-	90 rpm	90 rpm	-
@ 38 gpm (144 L/min.).....	-	-	-	-	98 rpm
<b>Torque</b>					
@ 2000 psi (19,788 kPa).....	1,300 ft.lb. (1,763 Nm)	1,300 ft.lb. (1,763 Nm)	2,520 ft.lb. (3,417 Nm)	2,520 ft.lb. (3,417 Nm)	2,387 ft.lb. (3,237 Nm)
@ 2400 psi (16,547 kPa).....	1,560 ft.lb. (2,115 Nm)	1,560 ft.lb. (2,115 Nm)	3,024 ft.lb. (4,100 Nm)	3,024 ft.lb. (4,100 Nm)	2,864 ft.lb. (3,884 Nm)
@ 2600 psi (17,926 kPa).....	-	-	-	-	3,103 ft.lb. (4,208 Nm)
@ 2700 psi (18,616 kPa).....	1,775 ft.lb. (2,379 Nm)	1,775 ft.lb. (2,379 Nm)	3,402 ft.lb. (4,213 Nm)	3,402 ft.lb. (4,213 Nm)	-
@ 3000 psi (20,684 kPa).....	1,950 ft.lb. (2,644 Nm)	1,950 ft.lb. (2,644 Nm)	3,780 ft.lb. (5,125 Nm)	3,780 ft.lb. (5,125 Nm)	-
@ 3200 psi (22,753 kPa).....	-	-	-	-	3,819 ft.lb. (5,179 Nm)
@ 3300 psi (22,753 kPa).....	2,415 ft.lb. (2,908 Nm)	2,415 ft.lb. (2,908 Nm)	4,158 ft.lb. (5,638 Nm)	4,158 ft.lb. (5,638 Nm)	-

**Auger**  
**VersaHANDLER® TTC ATTACHMENT**

@ 3500 psi (24,132 kPa).....	2,275 ft.lb. (3,084 Nm)	2,275 ft.lb. (3,084 Nm)	4,410 ft.lb. (5,979 Nm)	4,410 ft.lb. (5,979 Nm)	4,177 ft.lb. (5,664 Nm)
------------------------------	----------------------------	----------------------------	----------------------------	----------------------------	----------------------------

Part Number	Description	Attachment	Retail Price in US \$	Labor
<b>(V519) (TL619)</b>				
6809442	Model 15C Auger Drive Unit..... (Must also order Mounting Frame and Bit)		\$2,276.52	\$ -
7145345	Model 15H Hex Shaft Auger Drive Unit..... (Must also order Mounting Frame and Bit)		\$2,276.52	\$ -
6809445	Model 30C Auger Drive Unit..... (Must also order Mounting Frame and Bit)		\$2,975.57	\$ -
7138264	Model 30H Hex Shaft Auger Drive Unit..... (Must also order Mounting Frame and Bit)		\$2,975.57	\$ -
7220280	Model 35PH Auger Drive Unit..... (Must also order Mounting Frame and Bit)		\$4,590.02	\$ -

Part Number	Description	Dealer Installed Accessories - Order From Sales	Labor
<b>Must order Mounting Frame or Adapter Frame</b>			
V519 6812980	Auger 15C/H, 30C/H Mounting Frame..... (Includes Mounting Hardware)	\$619.96	\$ -
V519 7223507	35PH Mounting Frame..... (Includes Mounting Hardware)	\$739.43	

**Bucket**  
**VersaHANDLER® TTC ATTACHMENT**

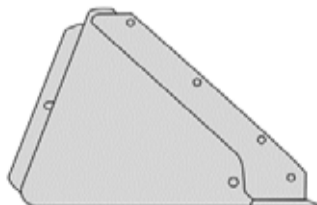

Part	Attachment	Oper. WGT.
	SAE Heaped	

Number	Description	Capacity (YD)	(lbs.)	Retail Price	Labor
(V519) (TL6)					
7326128	86" Severe Duty Bucket (•).....	26.2	849	\$2,562.05	\$ -
7326127	92" Severe Duty Bucket (•).....	27.5	892	\$2,462.03	\$ -
7279105	98" Light Material Bucket (••).....	53.8	914	\$2,871.53	\$ -
(V723, V923)					
7329888	93" General Purpose Bucket.....	1.0	919	\$3,879.71	\$ -
7338655	96" Light Material Bucket (•••).....	2.5	1,554	\$4,798.22	\$ -
7338662	96" Light Material XL Bucket (•••).....	3.2	1,753	\$6,098.99	\$ -

- (•) Buckets have holes predrilled to accept bolt-on teeth
- (••) Bucket has holes predrilled to accept bolt-on cutting edges
- (•••) Bucket has bolt-on cutting edge

7196474	Bucket Spill Guard, Standard.....			\$422.75	\$ -
---------	-----------------------------------	--	--	----------	------

**Combination Bucket**  
**VersaHANDLER® TTC ATTACHMENT**

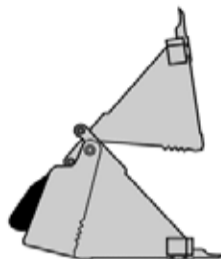

**Quick Specs**

	<b>84"</b>
Operating Weight.....	1,109 lbs.
Overall Width.....	85.4"
SAE Capacity Heaped.....	19.3 ft3
Number of Teeth.....	9 bolt-on
Max Clamping Force.....	6,835 lbs.

Part Number	Description	Attachment	Retail Price in US \$	Labor
(V519) (TL619)				
7167314	84" Combination Bucket.....		\$6,070.84	\$ -

**Flail Cutter**  
**VersaHANDLER® TTC ATTACHMENT**

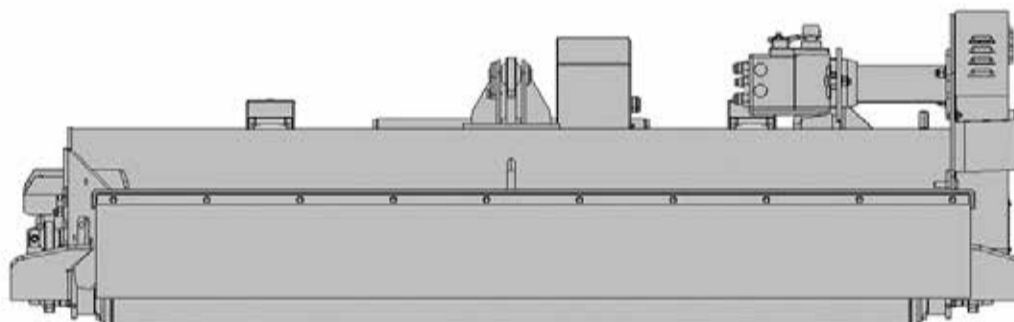

**Quick Specs**

Operating Weight.....	1,640 lbs.
Cutting Width.....	79"
Cutting Height.....	1.5" - 3"
Overall Width.....	91"
Flow.....	17 - 40 gpm
Hammers.....	21
Cutting Capacity.....	Brush material up to 3" in diameter
Blade Tip Speed.....	8,200 ft./min. @ 2,000 RPM 9,000 ft./min. @ 2,200 RPM

Part Number	Description	Attachment	Retail Price in US \$	Labor
(V519) (TL619)				
7101894	FC200 Flail Cutter.....		\$16,209.81	\$ -

**Grapple, AG & Industrial**  
**VersaHANDLER® TTC ATTACHMENT**



**Ag Grapple**

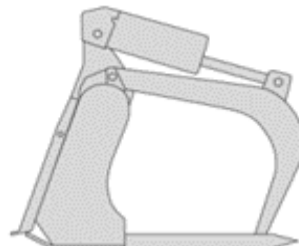

**Industrial Fork Grapple**

**Quick Specs**

	<u>96" Ag Bkt.</u>	<u>78" Fork</u>
Operating Weight.....	1,728 lbs.	1,218 lbs.
Overall Grapple Width.....	96.45"	78.8"
# of Teeth - Factory.....	N/A	8
# of Teeth - Possible.....	N/A	15

Part Number	Description	Attachment	Retail Price in US \$	Labor
(V519) (TL619) 7166624	78" Industrial Fork Grapple, With 8 Teeth.....		\$6,258.84	\$ -
(V723, V923) 7339833	96" Ag Bucket Grapple.....		\$9,580.79	\$ -

**Grapple Root**  
**VersaHANDLER® TTC ATTACHMENT**

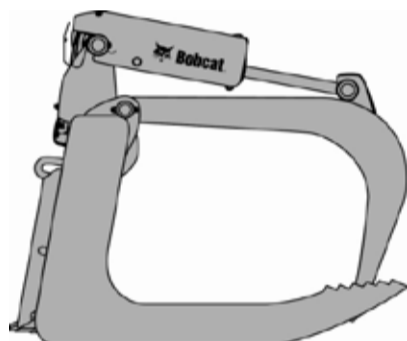

**Quick Specs**

	<u>82"</u>
Operating Weight.....	1,130 lbs.
Height (closed).....	34.2"
Height (open).....	51.8"
Length.....	42.8"
Width.....	82.5"
Teeth.....	11

Part Number	Description	Attachment	Retail Price in US \$	Labor
(V519) (TL619) 7168338	82" Root Grapple.....		\$5,122.74	\$ -

**Pallet Fork (Fixed)**  
**VersaHANDLER® TTC ATTACHMENT**

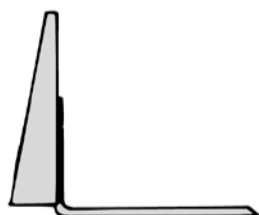

**Pallet Fork Teeth and Frame**

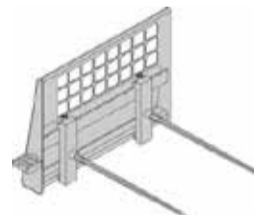

**Bale Forks (2) and Frame**

**Quick Specs**

	<u>V519</u>		<u>V723</u>	
<u>Frame</u> .....	<u>Fixed</u>		<u>Fixed</u>	<u>Fixed/SS</u>
Weight.....	358 lbs.		717 lbs.	893 lbs.
<u>Forks</u> .....	<u>42"</u>	<u>48"</u>	<u>Bale Forks</u>	<u>Single</u>
Ship Weight (set of 2).....	215 lbs.	238 lbs.	119 lbs.	42.7 lbs.
Fork Width.....	4"	4"	4"	4"

Telehandler Attachments

Part Number	Description	Attachment	Retail Price in US \$	Labor
(V519) (TL619) 7294332	Pallet Fork Frame, Heavy Duty, Less Teeth.....		\$914.93	\$ -
		<b><u>Bale Forks</u></b>		
6815781	Bale Forks, Set of 2.....		\$1,006.94	\$ -
		<b><u>Pallet Forks</u></b>		
6541521	42" Pallet Fork Teeth, Set of 2.....		\$602.02	\$ -
6541518	48" Pallet Fork Teeth, Set of 2.....		\$678.45	\$ -
(V723, V923) 7329891	Pallet Fork Frame, with 47" Teeth.....		\$2,105.85	\$ -
7328474	Pallet Fork Frame, with 47" Teeth and Sideshift.....		\$5,352.36	\$ -
		<b><u>Bale Fork</u></b>		
7329894	Bale Fork, Single.....		\$505.21	\$ -

**Pallet Fork (Floating)**  
**VersaHANDLER® TTC ATTACHMENT**

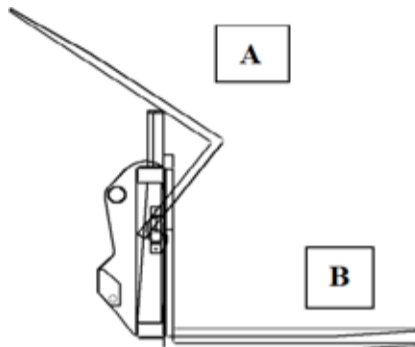

A – Lowback Forks will float and pivot up      B – Highback Forks will float only

**Quick Specs**

<u>Pallet Frames</u>	<u>48" Pallet Fork Frame</u>	<u>44" Frame</u>	<u>60" Frame</u>
Operating Weight.....	492 lbs.	617 lbs.	662 lbs.
Frame Width.....	49.9"	44.1"	60"
Frame Height.....	51.7"	-	-

<u>Pallet Forks</u>	<u>Lowback Forks</u>	<u>Highback Forks</u>
Operating Weight (set of 2).....	272 lbs.	316 lbs.
Fork Width.....	4"	4"
Fork Back Height.....	26"	39"
Fork Length.....	48"	48"
Float up/down.....	3"	-
Rotation.....	144°	-

Part Number	Description	Attachment	Retail Price in US \$	Labor
(V519) (TL619) 7140717	48" Pallet Fork Frame, Less Teeth.....		\$2,181.00	\$ -
6810302	48" Lowback Pallet Fork Teeth, set of 2.....		\$1,211.00	\$ -
6810301	48" Highback Pallet Fork Teeth, set of 2.....		\$1,557.00	\$ -
(V723) 7329892	44" Pallet Fork Frame, with 2 Low Back Forks.....		\$2,559.81	\$ -
(V723, V923) 7369521	60" Pallet Fork Frame, with 2 Low Back Forks.....		\$2,865.57	\$ -

**Rock Bucket**  
**VersaHANDLER® TTC ATTACHMENT**

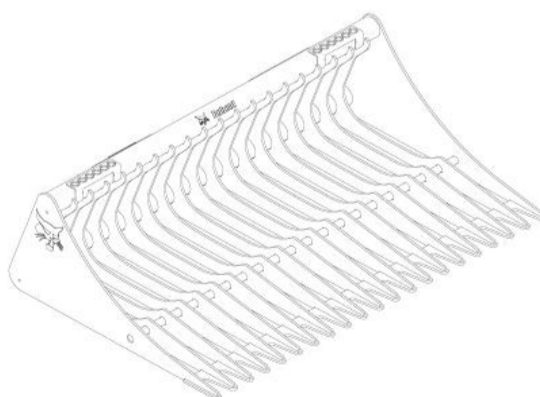

**Quick Specs**

	<b>82"</b>
Operating Weight.....	700 lbs.
Overall Width.....	82.1"
Overall Height.....	20.8"
Overall Length (Bucket Lip or Bottom of Bucket).....	43.57"
Tine Spacing.....	3"
Number of Tines.....	23

Part Number	Description	Attachment	Retail Price in US \$	Labor
(V519) (TL619) 7185947	82" Rock Bucket.....		\$2,712.57	\$ -

**Snow Blade**  
**VersaHANDLER® TTC ATTACHMENT**

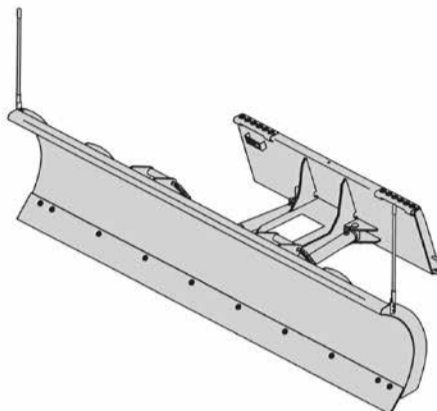

**Quick Specs**

	<b>108" HD</b>
Operating Weight.....	948 lbs.
Width.....	108"
Height.....	28.5"
Working Width (Fully Angled).....	94"
Steel Cutting Edge.....	.5" x 6"
Cylinders.....	1
Trip Springs.....	6
Optional Rubber Cutting Edge.....	1" x 6"

Part Number	Description	Attachment	Retail Price in US \$	Labor
(V519) (TL619) 7207863	108" Snow Blade - Heavy Duty (With Hydraulic Angle).....		\$5,680.54	\$ -

**Snow Pusher Pro**  
**VersaHANDLER® TTC ATTACHMENT**



**Quick Specs**

	<b>96"</b>	<b>108"</b>	<b>120"</b>
Operating Weight.....	1473 lbs	1529 lbs	1589 lbs
Overall Width.....	104"	116"	128"
Working Width.....	96"	108"	120"
Length (includes interface).....	75.8"	75.8"	75.8"
Height.....	40"	40"	40"
Cutting Edge (High Carbon Steel).....	5/8" x 6"	5/8" x 6"	5/8" x 6"
Skid Shoes (Poly).....	.36" x 9.75" x 1.5"	.36" x 9.75" x 1.5"	.36" x 9.75" x 1.5"
Number of Trip Springs.....	4	4	4
Color.....	Orange	Orange	Orange
<i>Float</i>			
Tilt.....	35 degrees	35 degrees	35 degrees
Oscillation.....	+/- 6 degrees	+/- 6 degrees	+/- 6 degrees

Part	Attachment
------	------------

Number	Description	Retail Price in US \$	Labor
(V519) (TL619) 7385513	96" Snow Pusher Pro.....	\$9,631.28	\$ -
7385514	108" Snow Pusher Pro.....	\$9,878.09	\$ -
7385515	120" Snow Pusher Pro.....	\$10,186.84	\$ -

**Soil Conditioner**  
**VersaHANDLER® TTC ATTACHMENT**

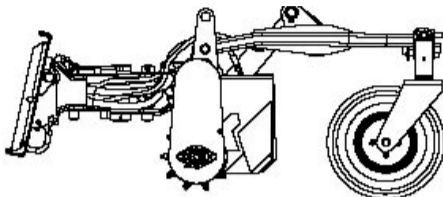

**Quick Specs**

	<b>84" Hydraulic</b>
Overall Length.....	67.9"
Overall Width.....	98.2"
Working Width (Fully Angled).....	76.0"
Degree of Angle - Left or Right.....	25 deg.
Number of Teeth.....	141
Operating Weight.....	1,268 lbs.
Hydraulic Requirements.....	18-37 gpm
Tires.....	Foam-Filled
Float or Lock Position.....	Both
Depth Adjustment.....	Hydraulic

Part Number	Description	Attachment	Retail Price in US \$	Labor
(V519) (TL619) 7135946	84" Soil Conditioner, Hydraulic Angle.....		\$12,589.51	\$ -

**Sweeper**  
**VersaHANDLER® TTC ATTACHMENT**

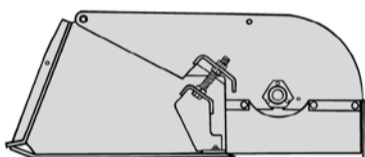

**Quick Specs**

	<b>84"</b>
Operating Weight.....	1,029 lbs.
Sweep Width.....	84"
Overall Attachment Width.....	89.9"
Bucket Capacity.....	18.5 cu. ft.
Broom Diameter.....	24"
Bristle Sections (Included).....	42
Bristle Material.....	Replaceable Polypropylene sections (steel sections available)
Cutting Edge (Repl. Steel).....	5/8" x 6"
Broom RPM @ 10 GPM.....	215 @ 15 GPM
Travel.....	Forward/Reverse

Part Number	Description	Attachment	Retail Price in US \$	Labor
(V519) (TL619) 7418178	84" Sweeper.....		\$6,529.58	\$ -

Part Number	Dealer Installed Accessories - Order From Sales Description	Labor
7419388	Gutter Brush..... (Includes hoses, couplers, steel bristles, mounting frame, hardware and control valve) (Estimated install time 2 hours) (Ship Weight 145 lbs.)	\$ 270.00

**Truss Boom**  
**VersaHANDLER® TTC ATTACHMENT**

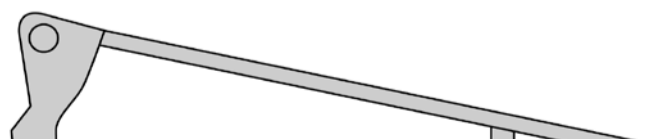

Telehandler Attachments

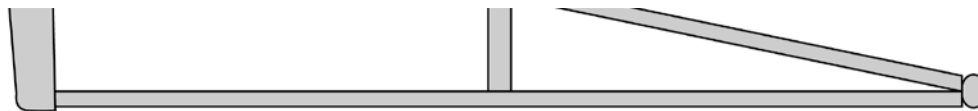

**Quick Specs**

Boom Weight..... 558 lbs.  
 Boom Height..... 19.3"  
 Boom Length..... 146"

Part Number	Description	Attachment	Retail Price in US \$	Labor
(V519) (TL619) 7140714	12' Truss Boom..... <small>(Truss Boom is outfitted with Bob-Tach® Mounting system tabs to prevent use on any carrier other than the V417 or V519)</small>		\$2,363.55	\$ -